

ULTRA LOW CAPACITANCE STEERING DIODE/TVS ARRAY

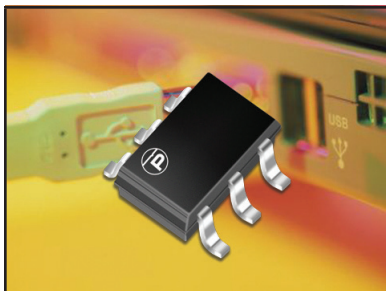

SOT-23-6 PACKAGE

DESCRIPTION

The PUSB05UBK is a high-powered, ultra low capacitance device for dual USB port and power bus protection. The PUSB05UBK is rated for 5.0V applications, with 500 Watts peak pulse power per line (8/20 μ s) and an ultra low capacitance of 2.5pF (C_{J(SD)}). The PUSB05UBK is ideally suited for surge suppression and ESD protection of high-speed data line applications such as video graphic cards, 3G cellular handsets, gigabit Ethernet and SIMM cards.

The PUSB05UBK combines eight ultra low capacitance steering diodes for up to four individual data or transmission lines and one TVS diode for the power bus. This device is offered in the space-saving SOT-23-6 package configuration. The small package size minimizes the lead inductance, preventing overshoot voltages during high ESD current events. ProTek recommends that the PUSB05UBK be mounted near the connector on the PCB. This device meets and exceeds the ESD requirements of IEC 61000-4-2 and the EFT requirements of IEC 61000-4-4.

FEATURES

- Compatible with IEC 61000-4-2 (ESD): Air \pm 15kV, Contact \pm 8kV
- Compatible with IEC 61000-4-4 (EFT): 40A, 5/50ns
- Compatible with IEC 61000-4-5 (Surge): 24A, 8/20 μ s - Level 2(Line-Gnd) & Level 3(Line-Line)
- 500 Watts Peak Pulse Power per Line(tp = 8/20 μ s)
- ESD Protection > 25 kilovolts
- Low Clamping Voltage
- Protection for 4 Lines
- Ultra Low Capacitance C_{J(SD)}: 2.5pF Typical
- RoHS Compliant
- REACH Compliant

APPLICATIONS

- Gigabit Ethernet
- SMART Phones
- Portable Electronics
- Video Card Interfaces
- USB 1.0, USB 2.0 & USB 3.0
- DVI Interfaces

MECHANICAL CHARACTERISTICS

- Molded JEDEC SOT-23-6 Package
- Approximate Weight: 16 milligrams
- Lead-Free Nickel Paladium Gold Plating
- Solder Reflow Temperature:
Nickel-Paladium-Gold: Ni/Pd/Au, 96/3.5/0.5: 260-270°C
- Flammability Rating UL 94V-0
- 8mm Tape and Reel per EIA Standard 481

PIN CONFIGURATION

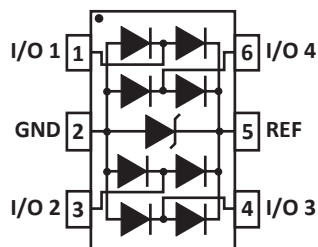

TYPICAL DEVICE CHARACTERISTICS
MAXIMUM RATINGS @ 25°C Unless Otherwise Specified

PARAMETER	SYMBOL	VALUE	UNITS
Peak Pulse Power (tp = 8/20μs) - See Figure 1	P _{PP}	500	Watts
Operating Temperature	T _L	-55 to 150	°C
Storage Temperature	T _{STG}	-55 to 150	°C
Forward Surge Rating (5ms @ 25°C, I _F = 50mA)	V _F	0.5 Min. - 1.2 Max.	Volts

ELECTRICAL CHARACTERISTICS PER LINE @ 25°C Unless Otherwise Specified

PART NUMBER	DEVICE MARKING	RATED STAND-OFF VOLTAGE (Note 1) V _{WM} VOLTS	MINIMUM BREAKDOWN VOLTAGE (Note 1) @ 1mA V _(BR) VOLTS	MAXIMUM CLAMPING VOLTAGE (Fig. 2) (Note 1) @ I _p = 1A V _C VOLTS	MAXIMUM CLAMPING VOLTAGE (Fig. 2) (Note 1) @ I _p = 5A V _C VOLTS	MAXIMUM LEAKAGE CURRENT (Note 1) @V _{WM} I _D μA
PUSB05UBK	W5	5.0	6.0	12.0	15.0	5

NOTES

1. Measured from I/O pin to ground.

TYPICAL CAPACITANCE I/O to GND	TYPICAL CAPACITANCE I/O to I/O	MAXIMUM CAPACITANCE I/O to GND	MAXIMUM CAPACITANCE I/O to I/O
@0V, 1MHz C _{J(SD)} pF	@0V, 1MHz C _{J(SD)} pF	@0V, 1MHz C _{J(SD)} pF	@0V, 1MHz C _{J(SD)} pF
3.5	2.5	5.0	4.0

TYPICAL DEVICE CHARACTERISTICS

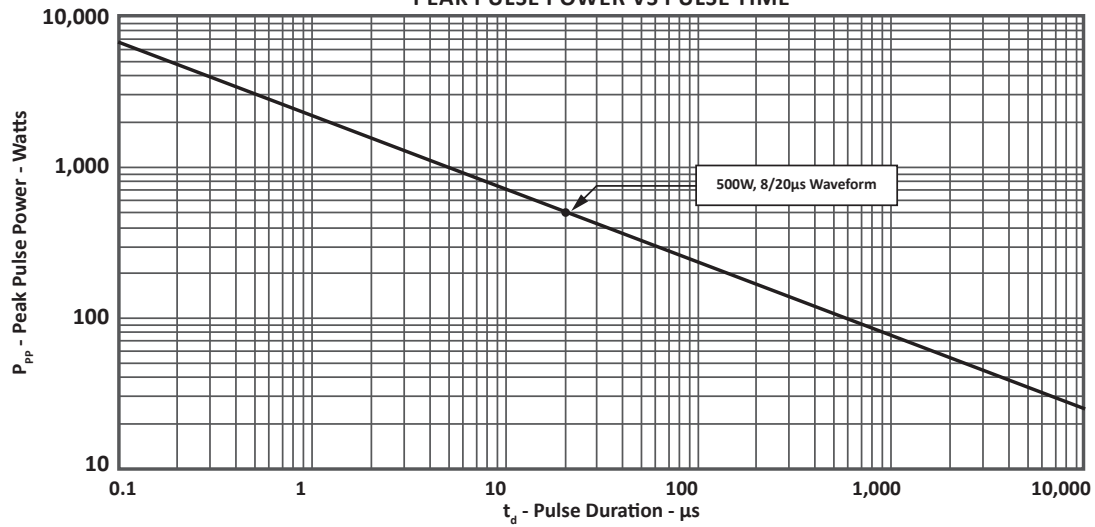
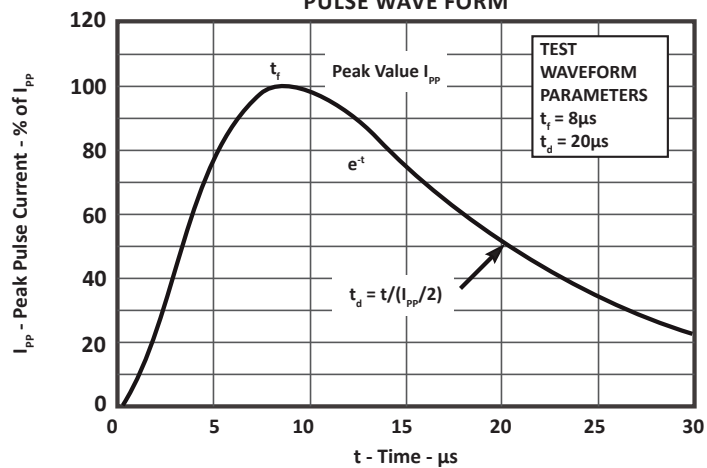
FIGURE 1
PEAK PULSE POWER VS PULSE TIME

FIGURE 2
PULSE WAVE FORM

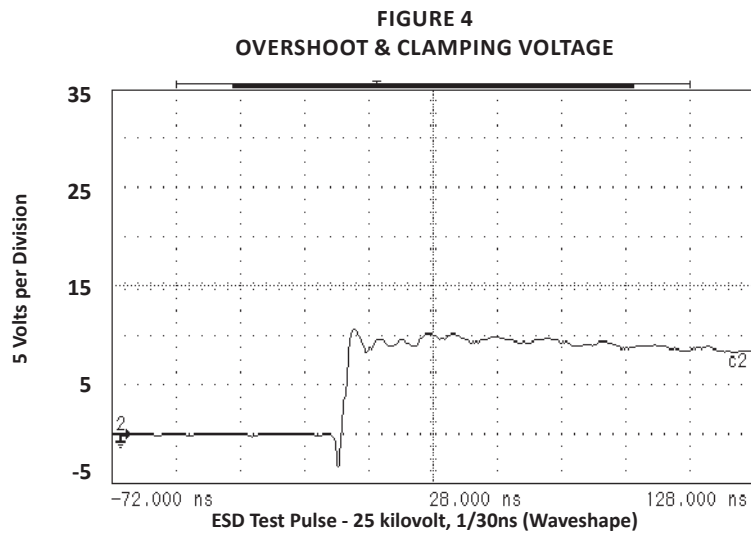
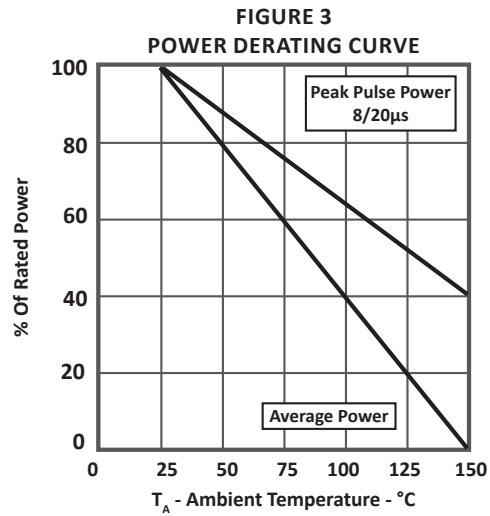
TYPICAL DEVICE CHARACTERISTICS



SOT-23-6 PACKAGE INFORMATION

OUTLINE DIMENSIONS

DIM	MILLIMETERS		INCHES	
	MIN	MAX	MIN	MAX
A	2.80	3.05	0.110	0.120
B	1.50	1.75	0.059	0.070
C	0.90	1.30	0.036	0.051
D	0.30	0.40	0.012	0.016
E	0.85	1.05	0.033	0.040
G	0.90	1.45	0.036	0.057
J	0.09	0.20	0.003	0.008
K	2.60	3.00	0.102	0.118
L	0.0	0.15	0.0	0.006
M	0.30	0.60	0.012	0.024

NOTES

- Controlling dimension: inches.
- Dimensioning and tolerances per ANSI Y14.5M, 1985.
- Dimensions are exclusive of mold flash and metal burrs.

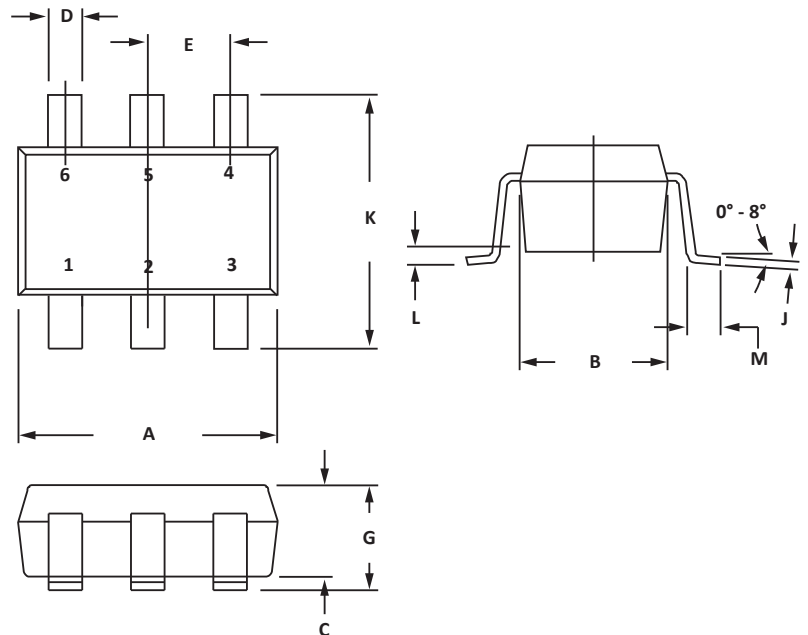

PAD LAYOUT DIMENSIONS

DIM	MILLIMETERS	INCHES
	NOMINAL	NOMINAL
A	0.70	0.028
B	1.90	0.074
C	0.95	0.037
D	2.40	0.094
E	1.00	0.039

NOTES

- Controlling dimension: inches.

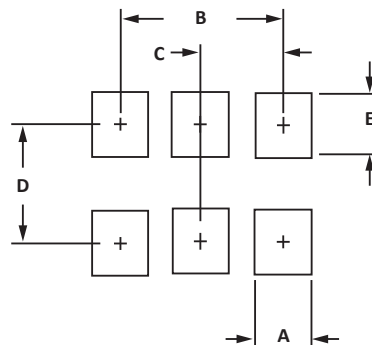

TAPE AND REEL

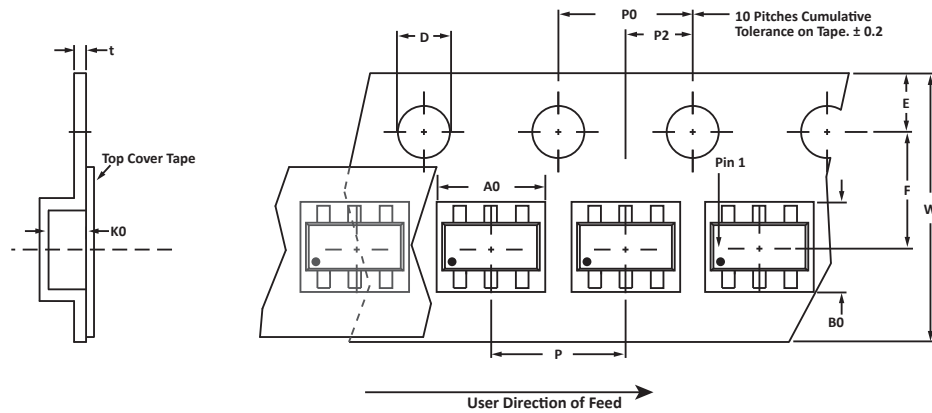

SPECIFICATIONS

REEL DIA.	TAPE WIDTH	A0	B0	K0	D	E	F	W	P0	P2	P	tmax
178mm (7")	8mm	3.20 ± 0.10	3.20 ± 0.10	1.65 ± 0.10	1.50 ± 0.10	1.75 ± 0.10	3.50 ± 0.05	8.00 ± 0.30	4.00 ± 0.10	2.00 ± 0.05	4.00 ± 0.10	0.25

NOTES

1. Dimensions are in millimeters.
2. Surface mount product is taped and reeled in accordance with EIA-481.
3. Suffix - T7 = 7" Reel - 3,000 pieces per 8mm tape.
4. Marking on Part - marking code (see page 2) and pin one defined by dot on package.

ORDERING INFORMATION

BASE PART NUMBER	LEADFREE SUFFIX	TAPE SUFFIX	QTY/REEL	REEL SIZE	TUBE QTY
PUSB05UBK	n/a	-T7	3,000	7"	n/a

This device is only available in a Lead-Free configuration.

COMPANY INFORMATION

COMPANY PROFILE

In business more than 20 years, ProTek Devices™ is a privately held semiconductor company. The company offers a product line of overvoltage protection and overcurrent protection components. These include transient voltage suppressor array (TVS arrays) avalanche breakdown diode, steering diode TVS array and electronics SMD chip fuses. These components deliver circuit protection in electronic systems from numerous overvoltage and overcurrent events. They include lightning; electrostatic discharge (ESD); nuclear electromagnetic pulses (NEMP); inductive switching; and electromagnetic interference (EMI) / radio frequency interference (RFI). ProTek Devices also offers LED wafer die for ESD protection and related high frequency products.

CONTACT US

Corporate Headquarters

2929 South Fair Lane
Tempe, Arizona 85282
USA

By Telephone

General: 602-431-8101
Sales: & Marketing: 602-414-5109
Customer Service: 602-414-5114
Product Technical Support: 602-414-5107

By Fax

General: 602-431-2288

By E-mail:

Asia Sales: asiasales@protekdevices.com
Europe Sales: europesales@protekdevices.com
U.S. Sales: ussales@protekdevices.com
Distributor Sales: distysales@protekdevices.com
Customer Service: service@protekdevices.com
Technical Support: support@protekdevices.com

ProTek Devices (Asia Pacific) Pte. Ltd.

8 Ubi Road 2, #06-19
Zervex
Singapore - 408538
Tel: +65-67488312
Fax: +65-67488313

Web

www.protekdevices.com

COPYRIGHT © ProTek Devices 2017 - This literature is subject to all applicable copyright laws and is not for resale in any manner.

SPECIFICATIONS: ProTek reserves the right to change the electrical and or mechanical characteristics described herein without notice.

DESIGN CHANGES: ProTek reserves the right to discontinue product lines without notice and that the final judgement concerning selection and specifications is the buyer's and that in furnishing engineering and technical assistance. ProTek assumes no responsibility with respect to the selection or specifications of such products. ProTek makes no warranty, representation or guarantee regarding the suitability of its products for any particular purpose, nor does ProTek assume any liability arising out of the application or use of any product or circuit and specifically disclaims any and all liability without limitation special, consequential or incidental damages.

LIFE SUPPORT POLICY: ProTek Devices products are not authorized for use in life support systems without written consent from the factory.