

500 WATT MULTI-LINE TVS ARRAY

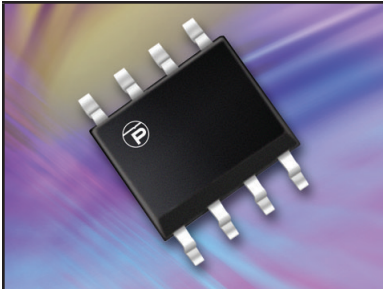

SO-8 PACKAGE

DESCRIPTION

The SMDAxxCM Series are monolithic transient voltage suppressor arrays that provides board level protection for standard TTL and MOS bus line applications against the damaging effects of ESD, tertiary lightning and switching transients.

The SMDAxxCM Series has a peak pulse power rating of 500 Watts for an 8/20 μ s waveshape. This device series meets the IEC 61000-4-2, IEC 61000-4-4 and IEC 61000-4-5 requirements.

FEATURES

- Compatible with IEC 61000-4-2 (ESD): Air - 15kV, Contact - 8kV
- Compatible with IEC 61000-4-4 (EFT): 40A - 5/50ns
- Compatible with IEC 61000-4-5 (Surge): 12A, 8/20 μ s - Level 1(Line-Gnd) & Level 2(Line-Line)
- 500 Watts Peak Pulse Power per Line (tp = 8/20 μ s)
- Bidirectional Configuration
- Available in Multiple Voltages Ranging from 5V to 24V
- Protects 4-7 Lines
- Monolithic Design
- RoHS Compliant
- REACH Compliant

APPLICATIONS

- RS-232, RS-422 & RS-423 Data Lines
- Microprocessor Based Equipment
- Control & Monitoring Systems
- Portable Electronics
- Sensor Electronics
- Medical Electronics

MECHANICAL CHARACTERISTICS

- Molded JEDEC SO-8 Package
- Approximate Weight: 70 milligrams
- Lead-Free Pure-Tin Plating (Annealed)
- Solder Reflow Temperature:
Pure-Tin - Sn, 100: 260-270°C
- 12mm Tape and Reel Per EIA Standard 481
- Flammability Rating UL 94V-0

PIN CONFIGURATION

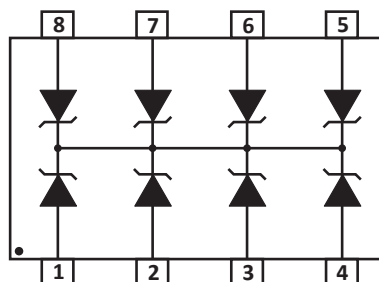

TYPICAL DEVICE CHARACTERISTICS

MAXIMUM RATINGS @ 25°C Unless Otherwise Specified

| PARAMETER | SYMBOL | VALUE | UNITS |
|---|-----------|------------|-------|
| Operating Temperature | T_L | -55 to 150 | °C |
| Storage Temperature | T_{STG} | -55 to 150 | °C |
| Peak Pulse Power (tp = 8/20µs) - See Figure 1 | P_{PP} | 500 | Watts |

ELECTRICAL CHARACTERISTICS PER LINE @ 25°C Unless Otherwise Specified

| PART NUMBER | DEVICE MARKING | RATED STAND-OFF VOLTAGE V_{WM} VOLTS | MINIMUM BREAKDOWN VOLTAGE @1mA $V_{(BR)}$ VOLTS | MAXIMUM CLAMPING VOLTAGE (Fig. 2) @ $I_p = 1A$ V_C VOLTS | MAXIMUM CLAMPING VOLTAGE (Fig. 2) @ 8/20µs $V_C @ I_{PP}$ | MAXIMUM LEAKAGE CURRENT @ V_{WM} I_D µA | MAXIMUM CAPACITANCE @0V, 1MHz C pF |
|-------------|----------------|--|--|---|---|--|---|
| SMDA05CM | REB | 5.0 | 6.0 | 9.8 | 19.0V @ 30.0A | 100 | 350 |
| SMDA08CM | REC | 8.0 | 8.5 | 13.4 | 23.7V @ 24.0A | 10 | 300 |
| SMDA12CM | RED | 12.0 | 13.4 | 19.0 | 29.2V @ 20.0A | 1 | 150 |
| SMDA15CM | REF | 15.0 | 16.7 | 24.0 | 31.1V @ 18.0A | 1 | 100 |
| SMDA24CM | REH | 24.0 | 26.7 | 43.0 | 45.0V @ 13.0A | 1 | 63 |

TYPICAL DEVICE CHARACTERISTICS

FIGURE 1
PEAK PULSE POWER VS PULSE TIME

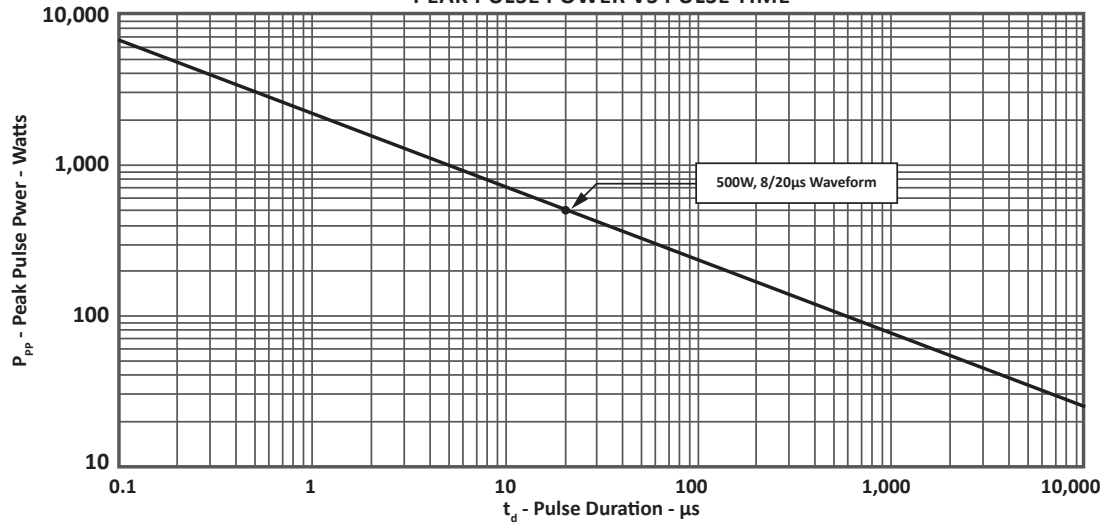

FIGURE 2
PULSE WAVE FORM

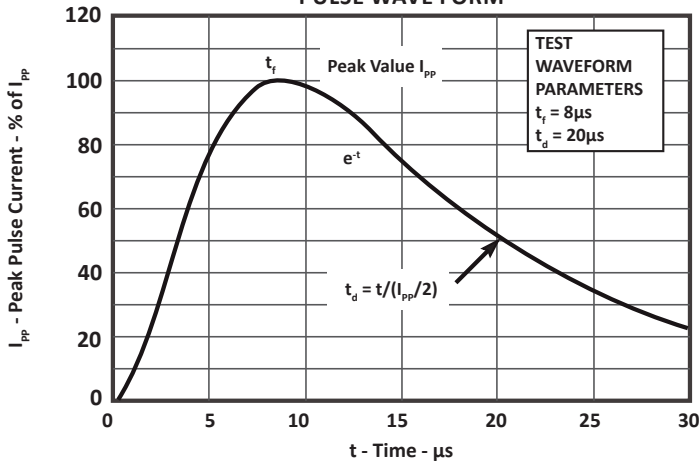
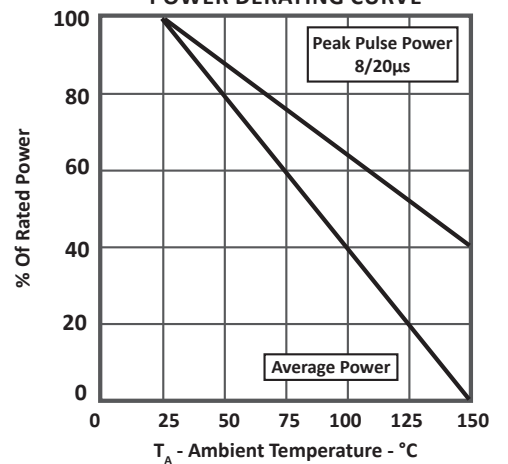

FIGURE 3
POWER DERATING CURVE



APPLICATION INFORMATION

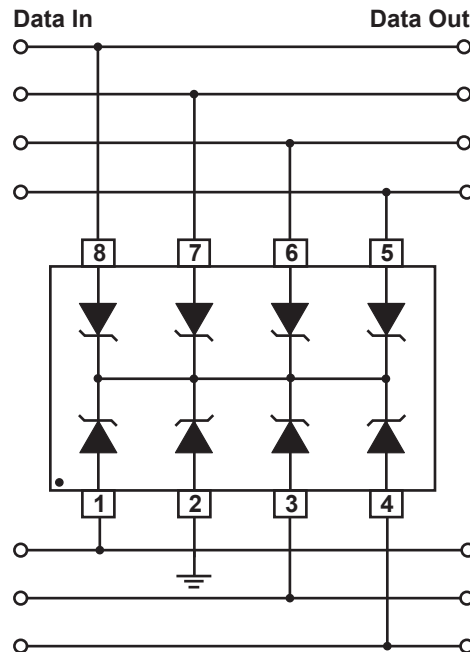

FIGURE 1 - UNIDIRECTIONAL COMMON-MODE PROTECTION

A SMDAxxCM can protect up to 7 I/O lines. Each, a bidirectional device, can be used on the data lines with signals that are ac in nature. i.e. their amplitude being positive and negative with respect to ground.

The standoff voltage (V_{WM}) and breakdown voltage (B_{VR}) specifications apply to the Differential voltage applied across any two pins. Taking the SMDA24CM as an example for further discussion, it being a 24V rated device it can handle $\pm 12V$ between any two lines. The SMDA24CM is connected as follows:

- Pins 1,3,4,5,6,7,8 are connected to the lines that need protection.
- Pin 2 is connected to ground. (Any one pin from Pins 2,3,6 and 7 can be chosen to be the ground pin. They provide shorter path to the current within the chip.) During PCB design ensure that the Ground connection made to Pin 2 is directly to the ground plane to avoid needless parasitic inductance that can be introduced by longer PCB traces.

CIRCUIT BOARD RECOMMENDATIONS

Circuit board layout is critical for electromagnetic compatibility protection. The following guidelines are recommended:

- The protection device should be placed near the input terminals or connectors, the device will divert the transient current immediately before it can be coupled into the nearby traces.
- The path length between the TVS device and the protected line should be minimized.
- All conductive loops including power and ground loops should be minimized.
- The transient current return path to ground should be kept as short as possible to reduce parasitic inductance.
- Ground planes should be used whenever possible. For multilayer PCBs, use ground vias.

SO-8 PACKAGE INFORMATION

OUTLINE DIMENSIONS

| DIM | MILLIMETERS | | INCHES | |
|-----|-------------|------|----------|-------|
| | MIN | MAX | MIN | MAX |
| A | 4.80 | 5.00 | 0.189 | 0.196 |
| B | 3.80 | 4.00 | 0.150 | 0.157 |
| C | 1.35 | 1.75 | 0.054 | 0.068 |
| D | 0.35 | 0.49 | 0.014 | 0.019 |
| F | 0.40 | 1.25 | 0.016 | 0.049 |
| G | 1.27 BSC | | 0.05 BSC | |
| J | 0.18 | 0.25 | 0.007 | 0.009 |
| K | 0.10 | 0.25 | 0.004 | 0.008 |
| P | 5.80 | 6.20 | 0.229 | 0.244 |
| R | 0.25 | 0.50 | 0.010 | 0.019 |

NOTES

- T = Seating plane and datum surface.
- Dimensions "A" and "B" are datum.
- Dimensions "A" and "B" do not include mold protrusion.
- Maximum mold protrusion is 0.015" (0.380mm) per side.
- Dimensioning and tolerances per ANSI Y14.5M, 1982.
- Dimensions are exclusive of mold flash and metal burrs.

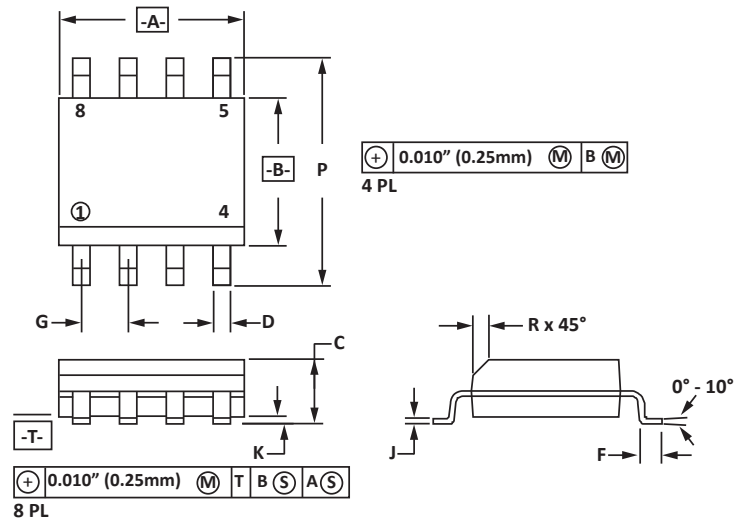

PAD LAYOUT DIMENSIONS

| DIM | MILLIMETERS | | INCHES | |
|-----|-------------|------|--------|-------|
| | MIN | MAX | MIN | MAX |
| A | 1.14 | 1.40 | 0.045 | 0.055 |
| B | 0.64 | 0.89 | 0.025 | 0.035 |
| C | 6.22 | - | 0.245 | - |
| D | 3.94 | 4.17 | 0.155 | 0.165 |
| E | 1.02 | 1.27 | 0.040 | 0.050 |

NOTES

- Controlling dimension: inches.

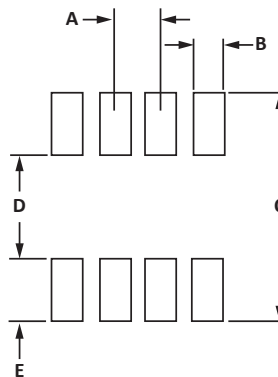

TAPE AND REEL

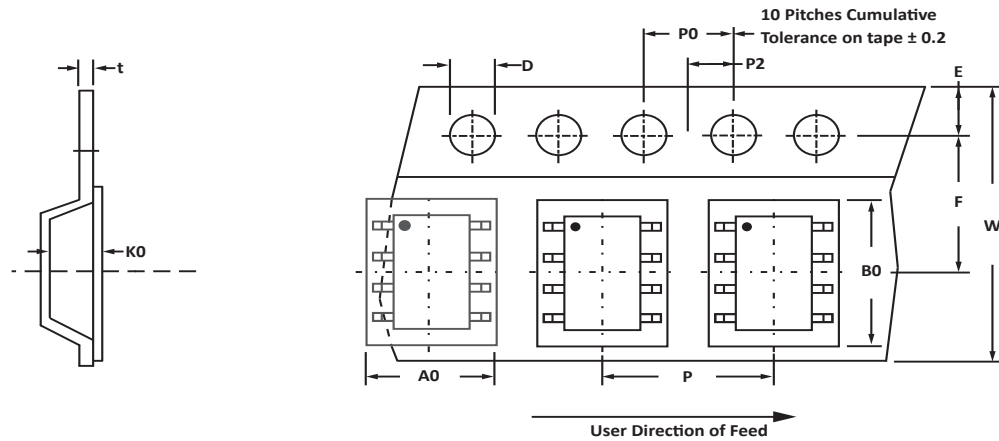

SPECIFICATIONS

| REEL DIA. | TAPE WIDTH | A0 | B0 | K0 | D | E | F | W | P0 | P2 | P | tmax |
|------------|------------|-------------|-------------|-------------|-------------|-------------|-------------|--------------|-------------|-------------|-------------|------|
| 178mm (7") | 12mm | 6.50 ± 0.10 | 5.40 ± 0.10 | 2.00 ± 0.10 | 1.50 ± 0.10 | 1.75 ± 0.10 | 5.50 ± 0.05 | 12.00 ± 0.30 | 4.00 ± 0.12 | 2.00 ± 0.10 | 8.00 ± 0.10 | 0.25 |

NOTES

- Dimensions are in millimeters.
- Surface mount product is taped and reeled in accordance with EIA-481.
- Suffix - T7 = 7" Reel - 1,000 pieces per 12mm tape.
- Suffix - T13 = 13" Reel - 2,500 pieces per 12mm tape.
- Bulk product shipped in tubes of 98 pieces per tube.
- Marking on Part - marking code (see page 2), date code, logo and pin one defined by dot on top of package.

ORDERING INFORMATION

| BASE PART NUMBER (xx = Voltage) | LEADFREE SUFFIX | TAPE SUFFIX | QTY/REEL | REEL SIZE | TUBE QTY |
|------------------------------------|-----------------|-------------|----------|-----------|----------|
| SMDAxxCM | -LF | -T7 | 1,000 | 7" | 98 |
| SMDAxxCM | -LF | -T13 | 2,500 | 13" | 98 |

This device is only available in a Lead-Free configuration.

COMPANY INFORMATION

COMPANY PROFILE

In business more than 20 years, ProTek Devices™ is a privately held semiconductor company. The company offers a product line of overvoltage protection and overcurrent protection components. These include transient voltage suppressor array (TVS arrays) avalanche breakdown diode, steering diode TVS array and electronics SMD chip fuses. These components deliver circuit protection in electronic systems from numerous overvoltage and overcurrent events. They include lightning; electrostatic discharge (ESD); nuclear electromagnetic pulses (NEMP); inductive switching; and electromagnetic interference (EMI) / radio frequency interference (RFI). ProTek Devices also offers LED wafer die for ESD protection and related high frequency products.

CONTACT US

Corporate Headquarters

2929 South Fair Lane
Tempe, Arizona 85282
USA

By Telephone

General: 602-431-8101
Sales: & Marketing: 602-414-5109
Customer Service: 602-414-5114
Product Technical Support: 602-414-5107

By Fax

General: 602-431-2288

By E-mail:

Asia Sales: asiasales@protekdevices.com
Europe Sales: europesales@protekdevices.com
U.S. Sales: ussales@protekdevices.com
Distributor Sales: distysales@protekdevices.com
Customer Service: service@protekdevices.com
Technical Support: support@protekdevices.com

ProTek Devices (Asia Pacific) Pte. Ltd.

8 Ubi Road 2, #06-19
Zervex
Singapore - 408538
Tel: +65-67488312
Fax: +65-67488313

Web

www.protekdevices.com

COPYRIGHT © ProTek Devices 2007 - This literature is subject to all applicable copyright laws and is not for resale in any manner.

SPECIFICATIONS: ProTek reserves the right to change the electrical and or mechanical characteristics described herein without notice.

DESIGN CHANGES: ProTek reserves the right to discontinue product lines without notice and that the final judgement concerning selection and specifications is the buyer's and that in furnishing engineering and technical assistance. ProTek assumes no responsibility with respect to the selection or specifications of such products. ProTek makes no warranty, representation or guarantee regarding the suitability of its products for any particular purpose, nor does ProTek assume any liability arising out of the application or use of any product or circuit and specifically disclaims any and all liability without limitation special, consequential or incidental damages.

LIFE SUPPORT POLICY: ProTek Devices products are not authorized for use in life support systems without written consent from the factory.