

SPICE MODEL & PARAMETERS

FIGURE 1
SPICE MODEL

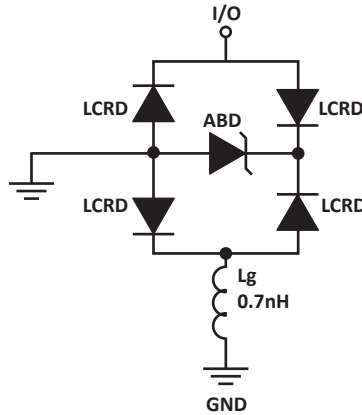

LCABD - Low Capacitance Avalanche Breakdown Diode (TVS)
LCRD: Low Capacitance Rectifier Diode
Lg - Lead Inductance

TABLE 1 - SPICE PARAMETERS			
PARAMETER	UNIT	ABD(TVS)	LCRD
BV	V	6.8	200
IBV	μA	1	0.01
C _{jo}	pF	3000	7
I _s	A	1E-12	1E-14
Vj	V	0.6	0.6
M	-	0.33	0.33
N	-	1	1
R _s	Ohms	0.075	0.32
TT	s	1E-8	1E-9
EG	eV	1.11	1.11

COMPANY INFORMATION

COMPANY PROFILE

ProTek Devices, based in Tempe, Arizona USA, is a manufacturer of Transient Voltage Suppression (TVS) products designed specifically for the protection of electronic systems from the effects of lightning, Electrostatic Discharge (ESD), Nuclear Electromagnetic Pulse (NEMP), inductive switching and EMI/RFI. With over 25 years of engineering and manufacturing experience, ProTek designs TVS devices that provide application specific protection solutions for all electronic equipment/systems.

ProTek Devices Analog Products Division, also manufactures analog interface, control, RF and power management products.

CONTACT US

Corporate Headquarters

2929 South Fair Lane
Tempe, Arizona 85282
USA

By Telephone

General: 602-431-8101
Sales: 602-414-5109
Customer Service: 602-414-5114

By Fax

General: 602-431-2288

By E-mail:

Sales: sales@protekdevices.com
Customer Service: service@protekdevices.com
Technical Support: support@protekdevices.com

Web

www.protekdevices.com
www.protekanalog.com

COPYRIGHT © ProTek Devices 2001 - This literature is subject to all applicable copyright laws and is not for resale in any manner.

SPECIFICATIONS: ProTek reserves the right to change the electrical and or mechanical characteristics described herein without notice.

DESIGN CHANGES: ProTek reserves the right to discontinue product lines without notice and that the final judgement concerning selection and specifications is the buyer's and that in furnishing engineering and technical assistance. ProTek assumes no responsibility with respect to the selection or specifications of such products. ProTek makes no warranty, representation or guarantee regarding the suitability of its products for any particular purpose, nor does ProTek assume any liability arising out of the application or use of any product or circuit and specifically disclaims any and all liability without limitation special, consequential or incidental damages.

LIFE SUPPORT POLICY: ProTek Devices products are not authorized for use in life support systems without written consent from the factory.