

AUTOMATION SENSOR TRANSIENT AND OVERVOLTAGE PROTECTION



DFN-3 PACKAGE

DESCRIPTION

The PDFN3-32 is designed to protect 24 Volt proximity sensors for factory automation sensory applications. This device provides switch and reverse blocking protection and is compliant with IEC 61000-4-2, IEC 61000-4-4 and IEC 61000-4-5 standards. Available in a DFN-3 package configuration, the PDFN3-32 is an excellent solution where board space is at a premium.

FEATURES

- Compatible with IEC 61000-4-2 (ESD): Air $\pm 15\text{kV}$, Contact $\pm 8\text{kV}$
- Compatible with IEC 61000-4-4 (EFT): 40A, 5/50ns
- Compatible with IEC 61000-4-5 (SURGE): 40A, 8/20 μs
- Compliant for Interface with Logic Input Type 1, 2, 3 IEC 61131-2
- Double Diode Array for Switch Protection and Reverse Blocking Protection
- Minimum Breakdown Voltage (V_{BR}): 34V
- Maximum Clamping Voltage: 55V @ 25A, 8/20 μs
- Blocking Diode Drop Forward Voltage (V_f): 1.1V @ 300mA
- Blocking Diode Maximum 10ms Square Pulse Current (I_{FSM}): 3A
- Ambient Operating Temperature: -40°C to 100°C
- RoHS Compliant
- REACH Compliant

APPLICATIONS

- Factory Automation Sensors
- Proximity Sensor Interfaces

MECHANICAL CHARACTERISTICS

- Molded DFN-3 Package
- Lead-Free Plating
- Solder Reflow Temperature - 260-270°C
- 8mm Tape and Reel Per EIA Standard 481
- Flammability Rating UL 94V-0

PINOUT CONNECTIONS

SYMBOL	DESCRIPTION
K	D1 Power Bus Protection Diode Cathode and D2 Reverse Blocking Protection Cathode
A1	D1 Power Bus Protection Diode Anode
A2	D2 Reverse Blocking Protection Anode

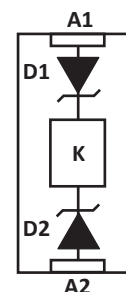

TYPICAL DEVICE CHARACTERISTICS
MAXIMUM RATINGS @ 25°C Unless Otherwise Specified

PARAMETER	SYMBOL	VALUE	UNITS
ESD Voltage Level per IEC 61000-4-2 (Air & Contact)	V_{ESD}	±30	kV
Peak Surge Voltage Level per IEC 61000-4-5, $R_{CC} = 500\Omega$	V_{PP}	1	kV
Peak Pulse Power ($t_p = 8/20\mu s$) - See Figure 2	P_{PP}	2800	Watts
Peak Pulse Power Dissipation	I_{PP}	40	Amps
Storage Junction Temperature Range	T_J	-40 to 150	°C

ELECTRICAL CHARACTERISTICS PER LINE @ 25°C Unless Otherwise Specified

PART NUMBER	DEVICE MARKING	RATED STAND-OFF VOLTAGE V_{WM} VOLTS	MINIMUM BREAKDOWN VOLTAGE	MAXIMUM BREAKDOWN VOLTAGE	MAXIMUM CLAMPING VOLTAGE (Fig. 3)	MAXIMUM CLAMPING VOLTAGE (Fig. 3)	MAXIMUM LEAKAGE CURRENT	MAXIMUM LEAKAGE CURRENT
			@ 1mA $V_{(BR)}$ VOLTS	@ 1mA $V_{(BR)}$ VOLTS	@ IP = 25A V_C VOLTS	@ IP = 40A V_C VOLTS	@ 32V I_D nA	@ 32V $T_J = 150^\circ C$ I_D μA
PDFN3-32	332	32	34	39	55	70	200	5

FIGURE 1
8/20 μs SURGE PERFORMANCE

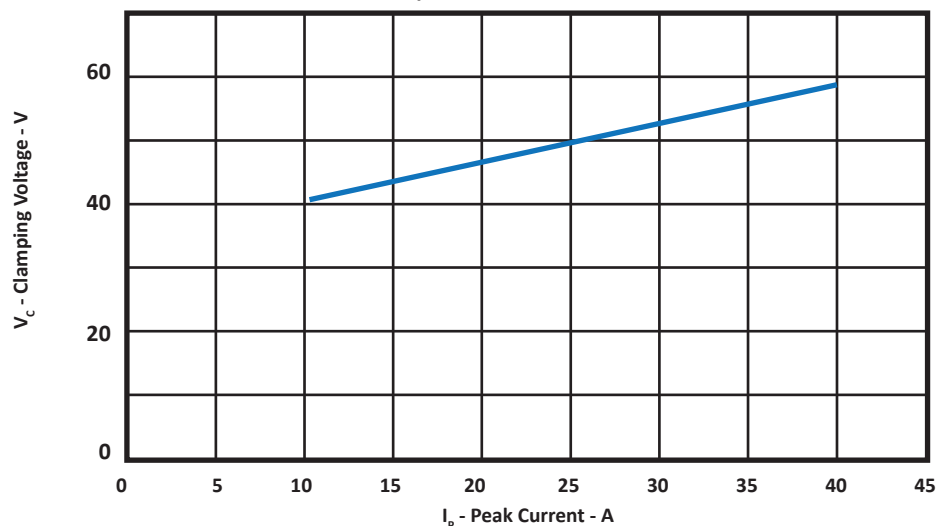

TYPICAL DEVICE CHARACTERISTICS

FIGURE 2
PEAK PULSE POWER VS PULSE TIME

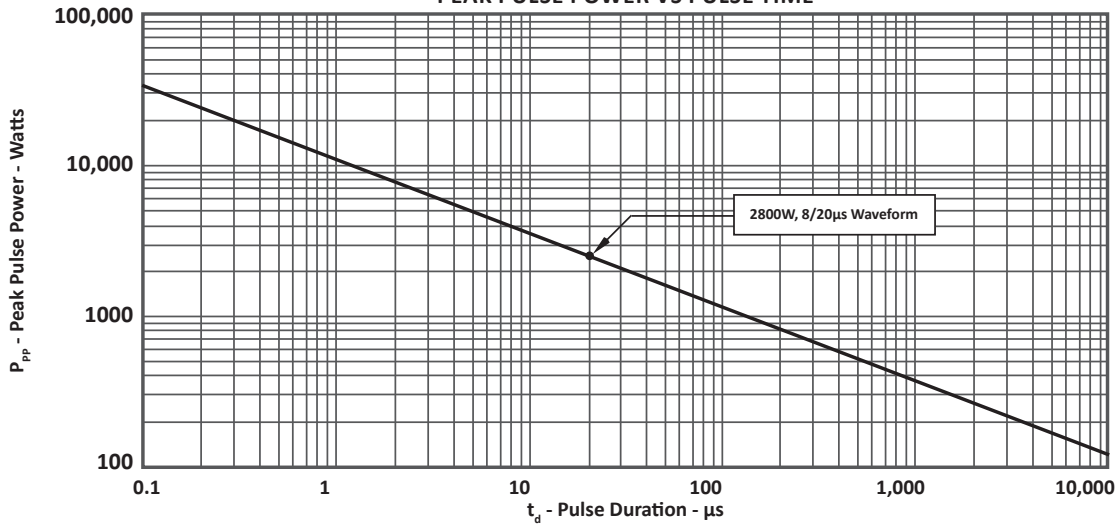

FIGURE 3
PULSE WAVE FORM

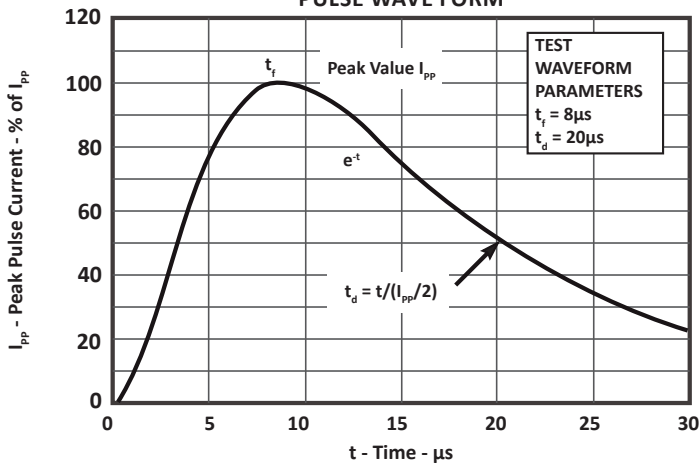
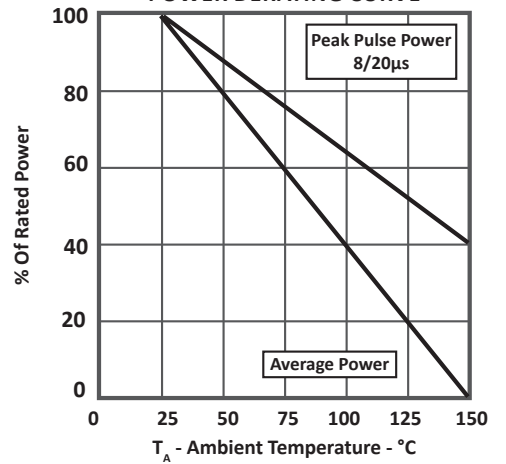
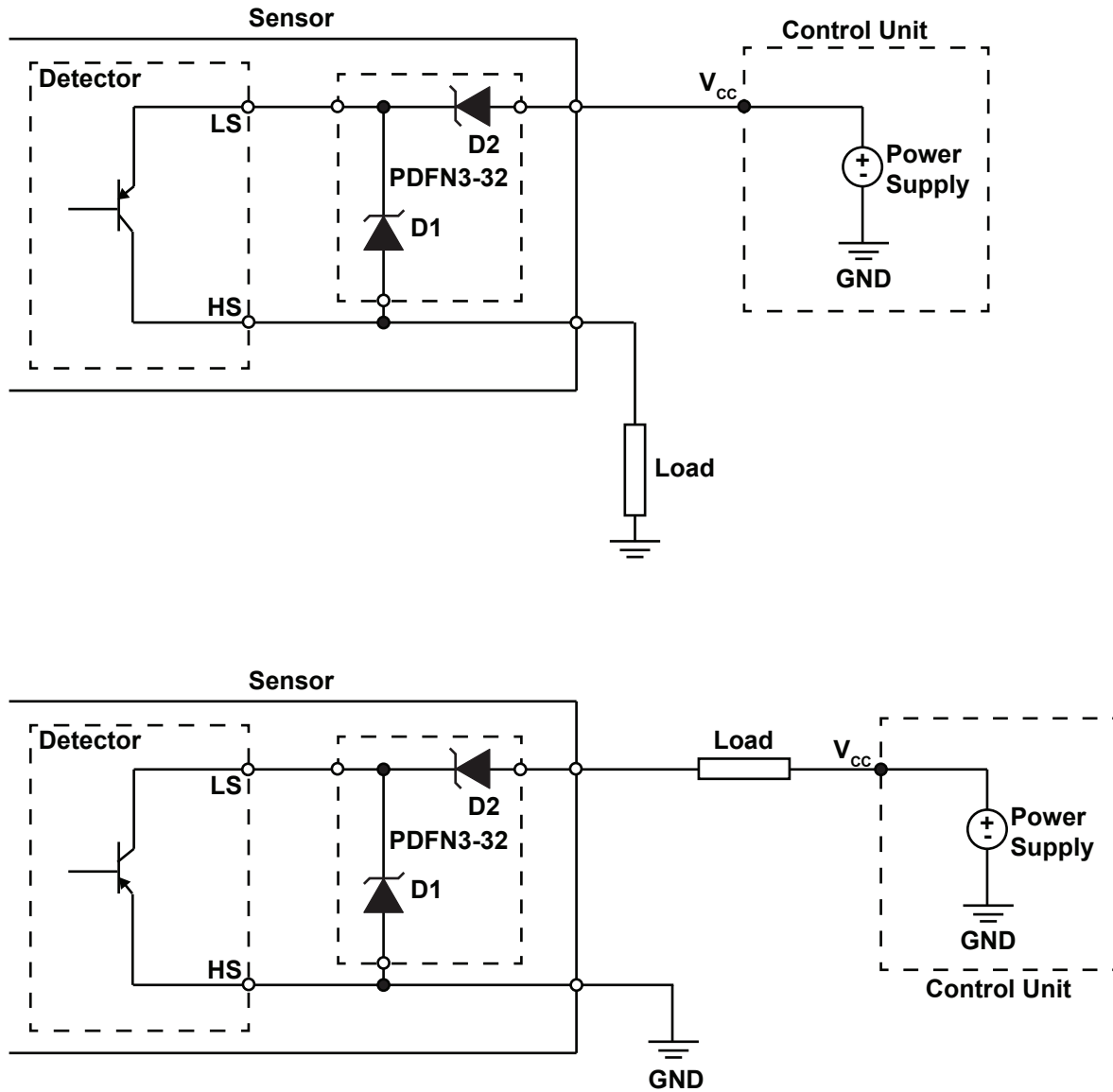

FIGURE 4
POWER DERATING CURVE



APPLICATION INFORMATION



PACKAGE INFORMATION

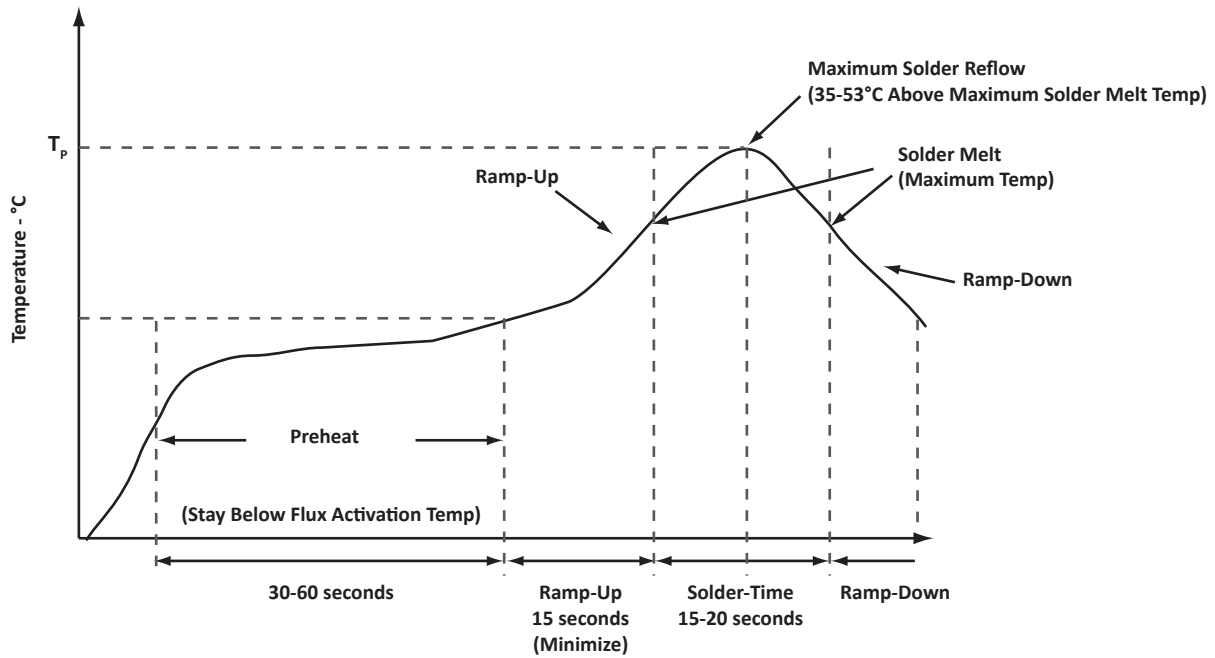

PACKAGE INFORMATION

OUTLINE DIMENSIONS				
DIM	MILLIMETERS		INCHES	
	MIN	MAX	MIN	MAX
A	3.40	3.50	0.134	0.138
B	1.47	1.57	0.055	0.065
C	0.23	0.33	0.009	0.013
D	1.96	2.06	0.077	0.081
E	1.02	1.12	0.040	0.044
F	2.79		0.110	
H	0.69	0.81	0.027	0.032
J	0.00	0.05	0.000	0.002

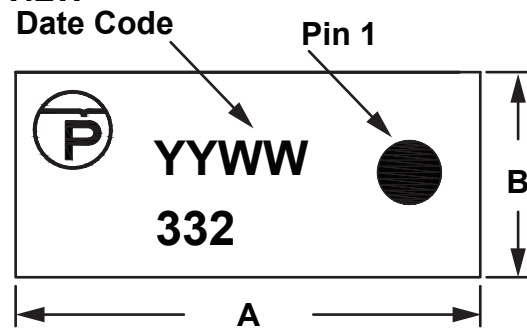
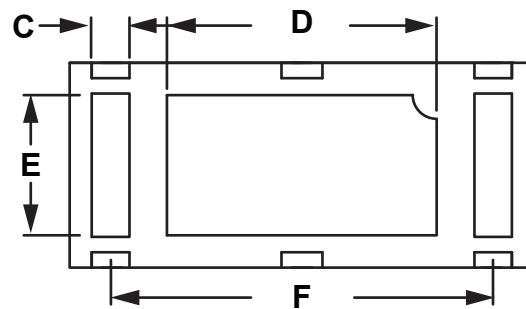
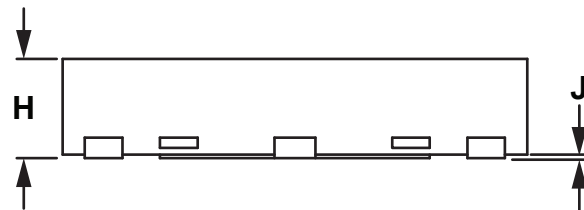
TOP VIEW

BOTTOM VIEW

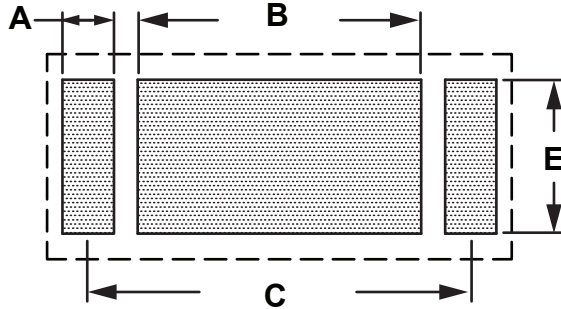
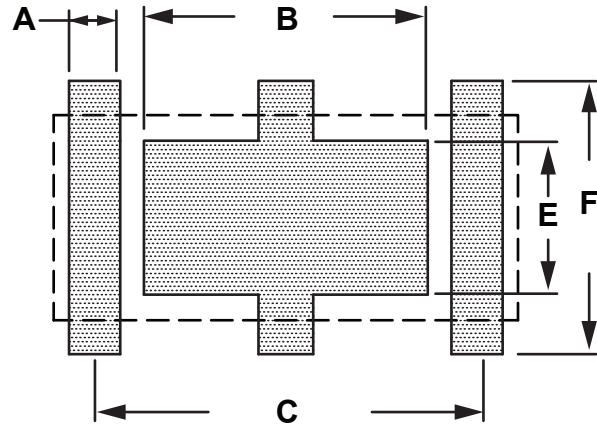
SIDE VIEW

PACKAGE INFORMATION

**WITHOUT VISUAL
INSPECTION JOINTS**

**WITH VISUAL
INSPECTION JOINTS**

PAD LAYOUT DIMENSIONS

DIM	MILLIMETERS	INCHES
	NOM	NOM
A	0.38	0.015
B	2.11	0.083
C	2.79	0.110
E	1.14	0.045

NOTES
1. Controlling dimension: millimeters.

PAD LAYOUT DIMENSIONS

DIM	MILLIMETERS	INCHES
	NOM	NOM
A	0.38	0.015
B	2.11	0.083
C	2.79	0.110
E	1.14	0.045
F	2.03	0.080

NOTES
1. Controlling dimension: millimeters.

TAPE AND REEL

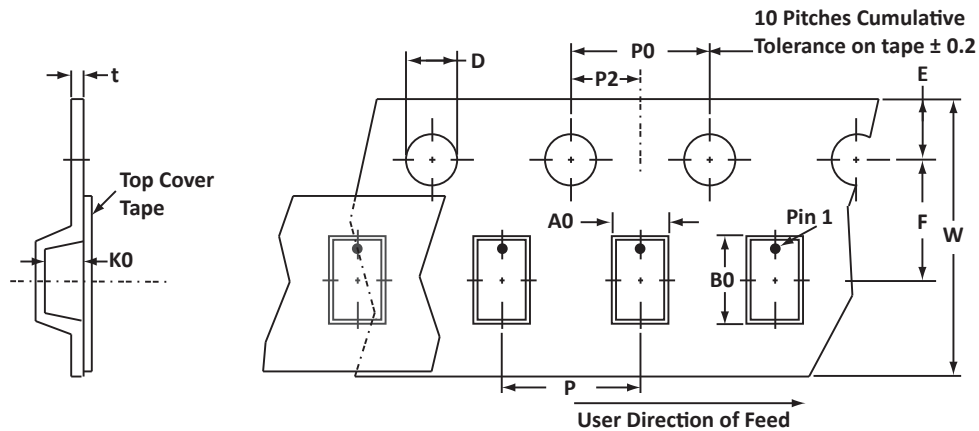

SPECIFICATIONS

REEL DIA.	TAPE WIDTH	A0	B0	K0	D	E	F	W	P0	P2	P	tmax
178mm (7")	8mm	1.78 ± 0.05	3.55 ± 0.05	1.00 ± 0.003	1.55 ± 0.10	1.75 ± 0.10	3.50 ± 0.05	8.00 ± 0.30	4.00 ± 0.10	2.00 ± 0.05	2.00 ± 0.05	0.25

NOTES

- Dimensions are in millimeters.
- Surface mount product is taped and reeled in accordance with EIA-481.
- Suffix - T73 = 7" Reel - 3,000 pieces per 8mm tape.
- Marking on Part - marking code, logo, date code and pin one (defined by a polarity dot).

ORDERING INFORMATION

BASE PART NUMBER	LEADFREE SUFFIX	TAPE SUFFIX	QTY/REEL	REEL SIZE	TUBE QTY
PDFN3-32	N/A	-T73	3,000	7"	N/A

This device is only available in a Lead-Free configuration.

COMPANY INFORMATION

COMPANY PROFILE

In business more than 25 years, ProTek Devices™ is a privately held semiconductor company. The company offers a product line of overvoltage protection and overcurrent protection components. These include transient voltage suppressor array (TVS arrays) avalanche breakdown diode, steering diode TVS array and electronics SMD chip fuses. These components deliver circuit protection in electronic systems from numerous overvoltage and overcurrent events. They include lightning; electrostatic discharge (ESD); nuclear electromagnetic pulses (NEMP); inductive switching; and electromagnetic interference (EMI) / radio frequency interference (RFI). ProTek Devices also offers LED wafer die for ESD protection and related high frequency products. ProTek Devices is ISO 9001:2015 certified.

CONTACT US

Corporate Headquarters

2929 South Fair Lane
Tempe, Arizona 85282
USA

By Telephone

General: 602-431-8101
Sales: & Marketing: 602-414-5109
Customer Service: 602-414-5114
Product Technical Support: 602-414-5107

By Fax

General: 602-431-2288

By E-mail:

Asia Sales: asiasales@protekdevices.com
Europe Sales: europesales@protekdevices.com
U.S. Sales: ussales@protekdevices.com
Distributor Sales: distysales@protekdevices.com
Customer Service: service@protekdevices.com
Technical Support: support@protekdevices.com

ProTek Devices (Asia Pacific) Pte. Ltd.

8 Ubi Road 2, #06-19
Zervex
Singapore - 408538
Tel: +65-67488312
Fax: +65-67488313

Web

www.protekdevices.com

COPYRIGHT © ProTek Devices 2017 - This literature is subject to all applicable copyright laws and is not for resale in any manner.

SPECIFICATIONS: ProTek reserves the right to change the electrical and or mechanical characteristics described herein without notice.

DESIGN CHANGES: ProTek reserves the right to discontinue product lines without notice and that the final judgement concerning selection and specifications is the buyer's and that in furnishing engineering and technical assistance. ProTek assumes no responsibility with respect to the selection or specifications of such products. ProTek makes no warranty, representation or guarantee regarding the suitability of its products for any particular purpose, nor does ProTek assume any liability arising out of the application or use of any product or circuit and specifically disclaims any and all liability without limitation special, consequential or incidental damages.

LIFE SUPPORT POLICY: ProTek Devices products are not authorized for use in life support systems without written consent from the factory.