

ULTRA LOW CAPACITANCE STEERING DIODE/TVS ARRAY

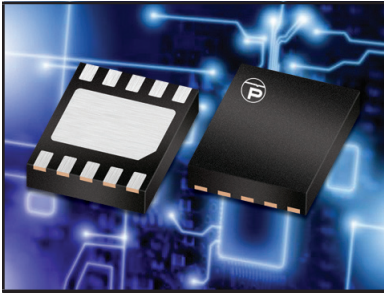

DFN-10 PACKAGE

DESCRIPTION

The PLR0508 is an ultra low capacitance steering diode/TVS array. This device is designed to protect computing applications such as gigabit Ethernet, HDMI, USB and DVI interfaces as well as telecommunication equipment and systems. The PLR0508 is available in the space-saving DFN-10 package configuration and is rated at 200 Watts peak pulse current (8/20 μ s waveshape).

This device meets the IEC 61000-4-2 (ESD), 61000-4-2 (EFT) and 61000-4-4 (Surge) requirements. At higher operating frequencies or faster edge rates, insertion loss and signal integrity are a major concern. This device in conjunction with passive components integrated into a TVS/filter network can be used for EMI/RFI protection.

FEATURES

- Compatible with IEC 61000-4-2 (ESD): Air - 15kV, Contact - 8kV
- Compatible with IEC 61000-4-4 (EFT): 40A - 5/50ns
- 200 Watts Peak Pulse Power per Line (tp = 8/20 μ s)
- ESD Protection > 25 kilovolts
- Low Clamping Voltage
- Unidirectional Configuration
- Protects 8 I/O Ports & Power Supply or 8 Lines
- Ultra Low Capacitance : 1.6pF (I/O to I/O)
- RoHS Compliant
- REACH Compliant

APPLICATIONS

- Gigabit Ethernet
- DVI, USB and HDMI Interfaces
- High-Speed Data Line ESD Protection
- FireWire, SATA & PCIe Interfaces

MECHANICAL CHARACTERISTICS

- Molded JEDEC DFN-10 Package
- Approximate Weight: 7 milligrams
- Lead-Free Pure-Tin Plating (Annealed)
- Solder Reflow Temperature:
Pure-Tin - Sn, 100: 260-270°C
- 12mm Tape and Reel Per EIA Standard 481
- Flammability Rating UL 94V-0

CIRCUIT DIAGRAM & PIN CONFIGURATION

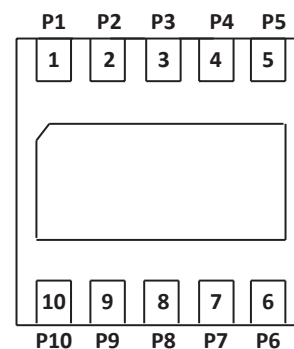
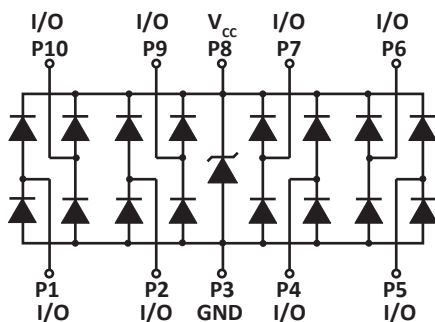

TYPICAL DEVICE CHARACTERISTICS
MAXIMUM RATINGS @ 25°C Unless Otherwise Specified

PARAMETER	SYMBOL	VALUE	UNITS
Peak Pulse Power (tp = 8/20μs) - See Figure 1	P_{PP}	200	Watts
Operating Temperature	T_L	-55 to 150	°C
Storage Temperature	T_{STG}	-55 to 150	°C

ELECTRICAL CHARACTERISTICS PER LINE @ 25°C Unless Otherwise Specified

PART NUMBER	DEVICE MARKING	RATED STAND-OFF VOLTAGE V_{WM} VOLTS	MINIMUM BREAKDOWN VOLTAGE @ 1mA $V_{(BR)}$ VOLTS	MAXIMUM CLAMPING VOLTAGE (Fig. 2) (Note 2) @ $I_p = 1A$ V_C VOLTS	MAXIMUM CLAMPING VOLTAGE (Fig. 2) (Note 2) @ $I_p = 5A$ V_C VOLTS	MAXIMUM LEAKAGE CURRENT @ V_{WM} I_D μA	TYPICAL CAPACITANCE (Note 1) @ 0V, 1MHz $C_{J(SD)}$ pF
PLR0508	508	5.0	6.0	9.8	13.0	1.0	1.6

NOTE

1. From I/O Pin to I/O.
2. Across TVS only (Pin 3 to 8).

TYPICAL DEVICE CHARACTERISTICS

FIGURE 1
PEAK PULSE POWER VS PULSE TIME

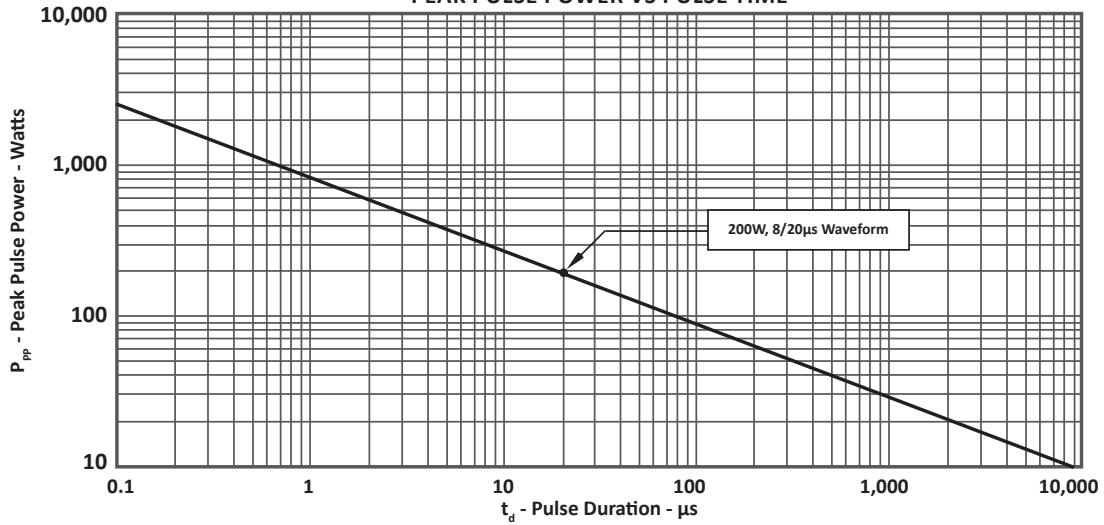

FIGURE 2
PULSE WAVE FORM

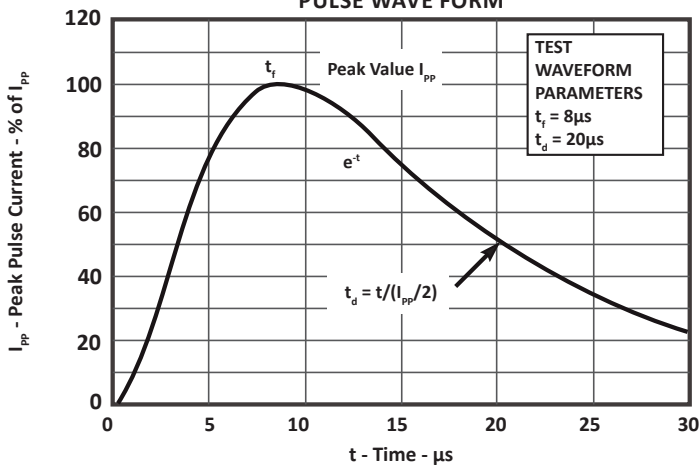
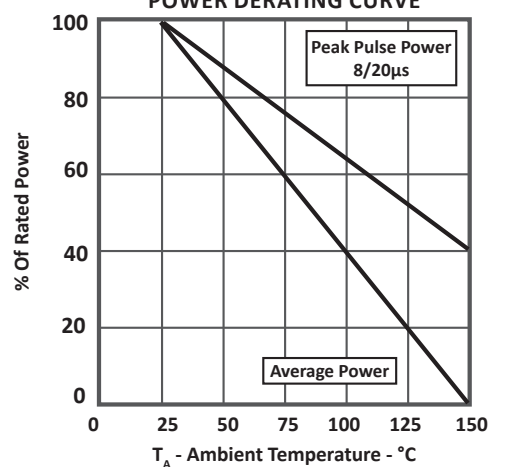

FIGURE 3
POWER DERATING CURVE



TYPICAL DEVICE CHARACTERISTICS

FIGURE 4
OVERSHOOT & CLAMPING VOLTAGE

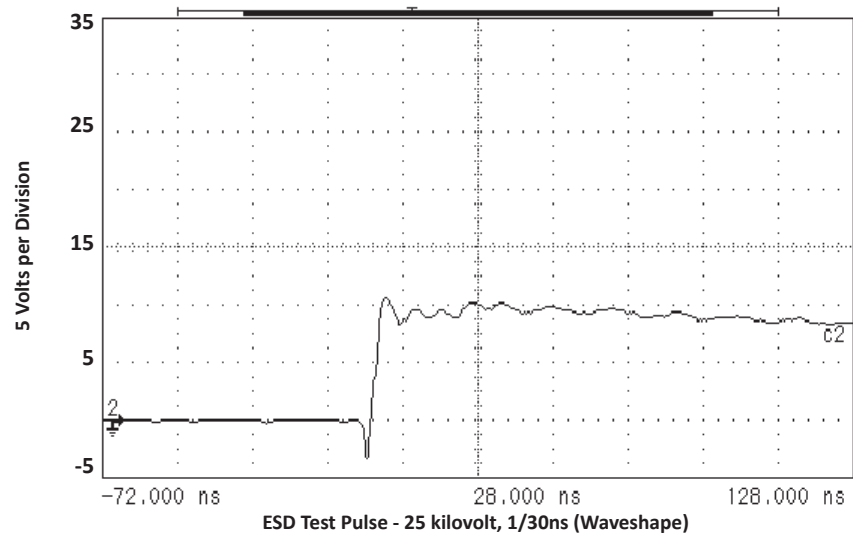
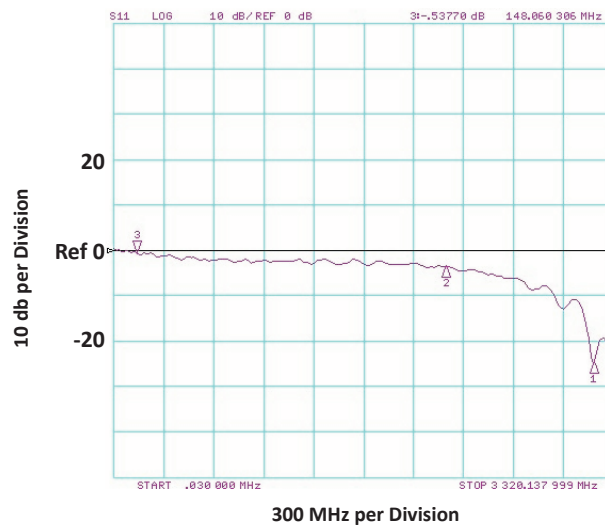

FIGURE 5
INSERTION LOSS



DFN-10 PACKAGE INFORMATION

OUTLINE DIMENSIONS

DIM	MILLIMETERS		INCHES	
	MIN	MAX	MIN	MAX
A	0.45	0.55	0.017	0.021
A2	0.13 BSC		0.005 BSC	
D	2.95	3.05	0.116	0.120
D2	2.45	2.55	0.096	0.100
E	2.95	3.05	0.116	0.120
E2	1.75	1.85	0.069	0.073
e	0.50 BSC		0.020 BSC	
L	0.35	0.45	0.013	0.017
M	0.25	0.45	0.010	0.018

NOTES

- Controlling dimension: millimeters.
- Dimensioning and tolerances per ANSI Y14.M, 1985.
- Coplanarity applies to the exposed pad as well as the terminals.

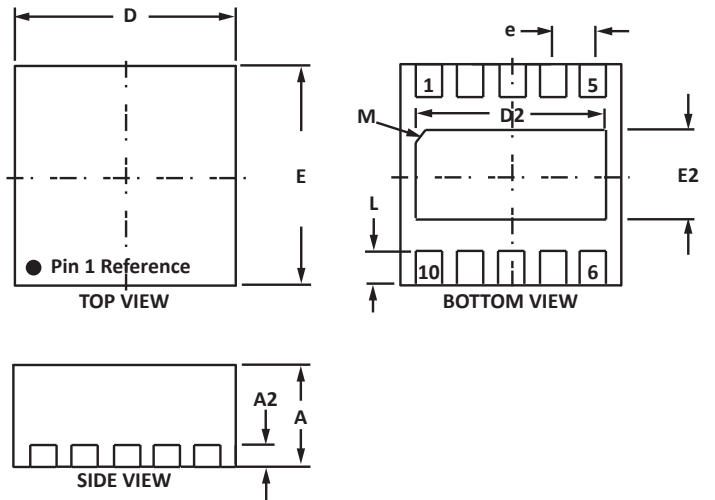

PAD LAYOUT DIMENSIONS

DIM	MILLIMETERS	INCHES
	NOMINAL	NOMINAL
A	2.34	0.092
B	1.88	0.074
C	3.00	0.118
D	0.50 BSC	0.020 BSC
E	0.30	0.012
F	0.81	0.032
G	2.60	0.102

NOTES

- Controlling dimension: millimeters.

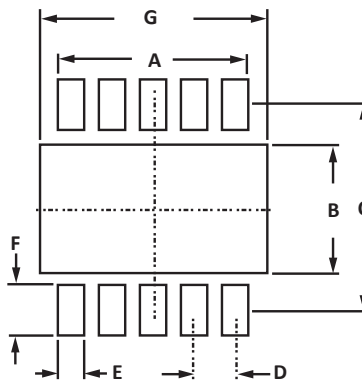

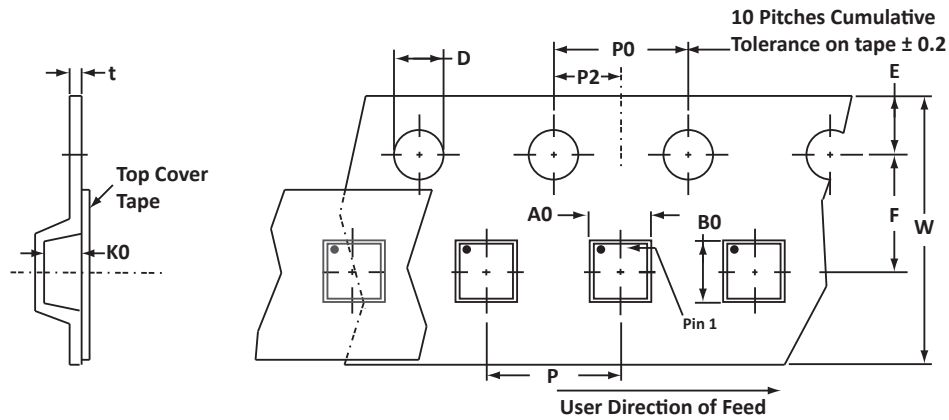
TAPE AND REEL

SPECIFICATIONS

REEL DIA.	TAPE WIDTH	A0	B0	K0	D	E	F	W	P0	P2	P	tmax
178mm (7")	12mm	3.56 ± 0.10	3.56 ± 0.10	0.69 ± 0.10	1.50 ± 0.10	1.75 ± 0.10	5.25 ± 0.05	12.00 ± 0.30	8.00 ± 0.10	4.00 ± 0.05	8.00 ± 0.10	0.25

NOTES

1. Dimensions are in millimeters.
2. Surface mount product is taped and reeled in accordance with EIA-481.
3. Suffix - T72 = 7" Reel - 2,000 pieces per 8mm tape.
4. Marking on Part - marking code (see page 2) and polarity dot.

Package outline, pad layout and tape specifications per document number 06080.R0 3/11.

ORDERING INFORMATION

BASE PART NUMBER	LEADFREE SUFFIX	TAPE SUFFIX	QTY/REEL	REEL SIZE	TUBE QTY
PLR0508	-LF	-T72	2,000	7"	n/a

This device is only available in a Lead-Free configuration.

COMPANY INFORMATION

COMPANY PROFILE

In business more than 25 years, ProTek Devices™ is a privately held semiconductor company. The company offers a product line of overvoltage protection and overcurrent protection components. These include transient voltage suppressor array (TVS arrays) avalanche breakdown diode, steering diode TVS array and electronics SMD chip fuses. These components deliver circuit protection in electronic systems from numerous overvoltage and overcurrent events. They include lightning; electrostatic discharge (ESD); nuclear electromagnetic pulses (NEMP); inductive switching; and electromagnetic interference (EMI) / radio frequency interference (RFI). ProTek Devices also offers LED wafer die for ESD protection and related high frequency products. ProTek Devices is ISO 9001:2015 certified.

CONTACT US

Corporate Headquarters

2929 South Fair Lane
Tempe, Arizona 85282
USA

By Telephone

General: 602-431-8101
Sales: & Marketing: 602-414-5109
Customer Service: 602-414-5114
Product Technical Support: 602-414-5107

By Fax

General: 602-431-2288

By E-mail:

Asia Sales: asiasales@protekdevices.com
Europe Sales: europesales@protekdevices.com
U.S. Sales: ussales@protekdevices.com
Distributor Sales: distysales@protekdevices.com
Customer Service: service@protekdevices.com
Technical Support: support@protekdevices.com

ProTek Devices (Asia Pacific) Pte. Ltd.

8 Ubi Road 2, #06-19
Zervex
Singapore - 408538
Tel: +65-67488312
Fax: +65-67488313

Web

www.protekdevices.com

COPYRIGHT © ProTek Devices 2006 - This literature is subject to all applicable copyright laws and is not for resale in any manner.

SPECIFICATIONS: ProTek reserves the right to change the electrical and or mechanical characteristics described herein without notice.

DESIGN CHANGES: ProTek reserves the right to discontinue product lines without notice and that the final judgement concerning selection and specifications is the buyer's and that in furnishing engineering and technical assistance. ProTek assumes no responsibility with respect to the selection or specifications of such products. ProTek makes no warranty, representation or guarantee regarding the suitability of its products for any particular purpose, nor does ProTek assume any liability arising out of the application or use of any product or circuit and specifically disclaims any and all liability without limitation special, consequential or incidental damages.

LIFE SUPPORT POLICY: ProTek Devices products are not authorized for use in life support systems without written consent from the factory.