



DESCRIPTION

The SM30KWExxA/CA Series are high-powered surface mount transient voltage suppression components designed to protect equipment and systems from the damaging effects of high voltage spikes. The surface mount package configuration provides a lower profile compared to legacy axial lead package configurations.

These devices provide 30 kilowatts of peak pulse power dissipation for an 10/1000 μ s waveform. Applications include AC and DC power line protection, terrestrial base station protection as well as module lightning protection.

FEATURES

- RTCA DO-160G COMPLIANT PRODUCT
- Waveforms (Pin Injection) 3 and 4 - Level 5; Waveform 5A - Level 4
- Low Clamping Voltage
- 30 kilowatts Peak Pulse Power per Line ($t_p = 10/1000\mu s$)
- Unidirectional & Bidirectional Configurations
- Easy Mounting to Printed Circuit Board
- Available in Multiple Voltages
- RoHS Compliant

APPLICATIONS

- Relay Drives
- Motor (Start/Stop) Back EMF Protection
- Module Lightning Protection
- Secondary Lightning Protection for AC/DC

MECHANICAL CHARACTERISTICS

- Molded Surface Mount Package
- Approximate Weight: 1.2 grams
- Lead-Free 100%Tin Plating
- Solder Reflow Temperature: 260-270°C, 10 seconds
- Flammability Rating UL 94V-0

CIRCUIT DIAGRAMS

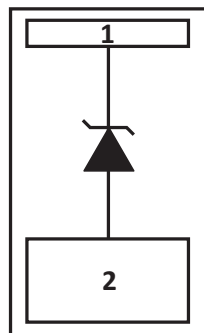

UNIDIRECTIONAL

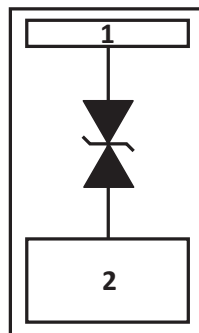

BIDIRECTIONAL

TYPICAL DEVICE CHARACTERISTICS

RTCA DO-160G COMPLIANT PRODUCT

MAXIMUM RATINGS @ 25°C Unless Otherwise Specified

PARAMETER	SYMBOL	VALUE	UNITS
Peak Pulse Power (tp = 10/1000µs) - See Figure 1	P _{PP}	30	kilowatts
Forward Surge Rating (Unidirectional Only)	I _F	200	Amps
Steady Power Dissipation	P _P	1.0	Amps
Storage Temperature	T _{STG}	-55 to +150	°C
Operating Temperature	T _J	-55 to +150	°C

ELECTRICAL CHARACTERISTICS PER LINE @ 25°C Unless Otherwise Specified

PART NUMBER	MARKING CODE		RATED STAND-OFF VOLTAGE V _{WM} VOLTS	MINIMUM BREAKDOWN VOLTAGE		MAXIMUM LEAKAGE CURRENT @V _{WM} I _D µA	MAXIMUM CLAMPING VOLTAGE (Fig. 2) @ 10/1000µs V _C @ I _{PP}
	UNI	BI		MIN V _(BR) VOLTS	@I _T mA		
SM30KWE16A	E3U16	E3B16	16.0	17.8	5	100	26.0V @ 1150A
SM30KWE20A	E3U20	E3B20	20.0	22.1	5	15	34.3V @ 874A
SM30KWE24A	E3U24	E3B24	24.0	26.7	5	15	40.7V @ 738A
SM30KWE28A	E3U28	E3B28	28.0	31.1	5	15	47.5V @ 632A
SM30KWE30A	E3U30	E3B30	30.0	33.3	5	10	50.7V @ 592A
SM30KWE33A	E3U33	E3B33	33.0	36.7	5	10	54.8V @ 548A
SM30KWE36A	E3U36	E3B36	36.0	40.0	5	10	59.7V @ 502A
SM30KWE40A	E3U40	E3B40	40.0	44.3	5	10	66.0V @ 455 A
SM30KWE43A	E3U43	E3B43	43.0	48.5	5	10	71.0V @ 423A
SM30KWE48A	E3U48	E3B48	48.0	53.3	5	10	73.2V @ 410A
SM30KWE51A	E3U51	E3B51	51.0	57.7	5	10	86.0V @ 351A
SM30KWE54A	E3U54	E3B54	54.0	60.0	5	10	87.1V @ 344A
SM30KWE60A	E3U60	E3B60	60.0	66.6	5	10	103.4V @ 290A
SM30KWE64A	E3U64	E3B64	64.0	73.0	5	10	106.6V @ 280A
SM30KWE70A	E3U70	E3B70	70.0	77.8	5	10	114.0V @ 264A
SM30KWE75A	E3U75	E3B75	75.0	83.3	5	10	122.0V @ 246A
SM30KWE78A	E3U78	E3B78	78.0	86.7	5	5	126.0V @ 238A
SM30KWE110A	E3U110	E3B110	110.0	121.0	5	5	178.0V @ 168A
SM30KWE120A	E3U120	E3B120	120.0	132.0	5	5	193.0V @ 156A
SM30KWE180A	E3U180	E3B180	180.0	200.0	5	5	295.0V @ 102A
SM30KWE345A	E3U345	E3B345	345	380.0	5	5	560.0V @ 53.6A

NOTES

1. Part numbers shown are unidirectional devices. Add a "CA" suffix to specify bidirectional devices, such as SM30KWE70CA.

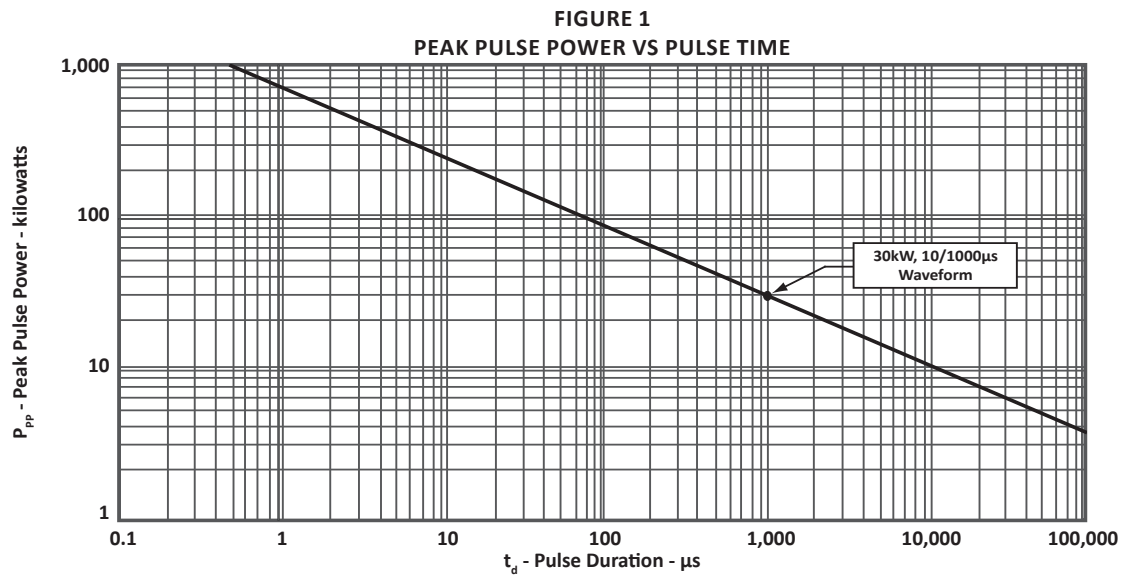
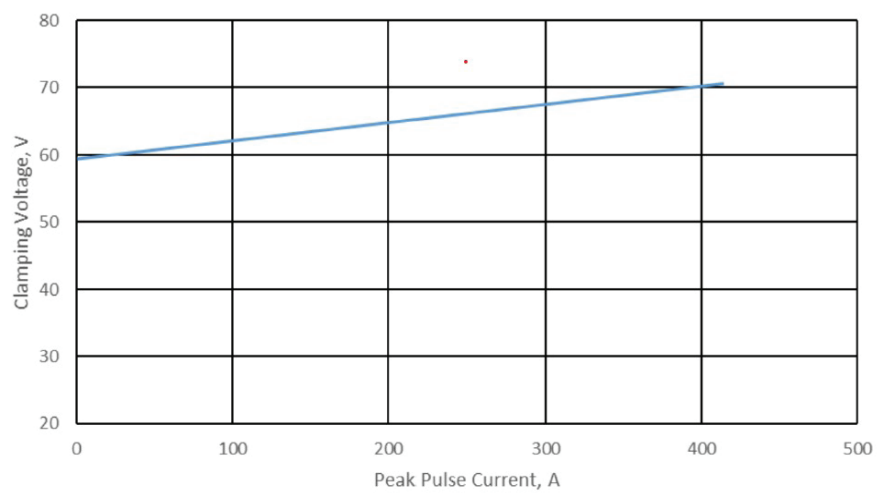
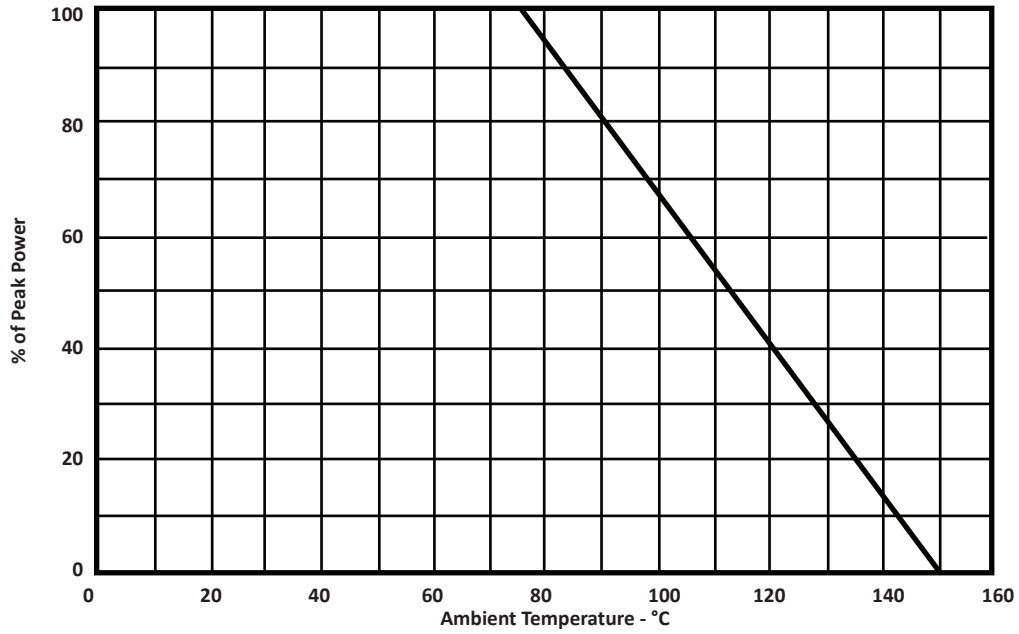

FIGURE 2
SM30KWE48CA CLAMPING VOLTAGE VS PEAK PULSE CURRENT 10/1000 μ s



TYPICAL DEVICE CHARACTERISTICS

**FIGURE 3
POWER DERATING CURVE**



PACKAGE INFORMATION

RTCA DO-160G COMPLIANT PRODUCT

OUTLINE DIMENSIONS

DIM	MILLIMETERS		INCHES	
	MIN	MAX	MIN	MAX
A	10.95	11.15	0.431	0.439
B	9.04	9.24	0.356	0.364
C	2.95	3.15	0.116	0.124
D	7.06	7.16	0.278	0.282
E	0.97	1.07	0.038	0.042
F	3.61	3.81	0.142	0.150
G	4.62	4.72	0.185	0.189
H	0.83	1.03	0.033	0.041
J	8.03	8.23	0.316	0.324
K	0.46	0.56	0.018	0.022
L	4.46	4.66	0.174	0.184
M	4.01	4.21	0.158	0.166
N	0.60	0.70	0.024	0.028
P	0.20	0.30	0.008	0.012

NOTES

1. Dimensions are exclusive of mold flash and metal burrs.
2. Polarity band for unidirectional parts only.

PCB PAD LAYOUT DIMENSIONS

DIM	MILLIMETERS		INCHES	
	MIN	MAX	MIN	MAX
A	0.80	0.95	0.032	0.038
B	1.07	1.22	0.042	0.048
C	4.54		0.179	
D	4.11		0.162	
E	9.04		0.356	
F	7.26	7.36	0.286	0.290
G	1.17	1.32	0.046	0.052
H	3.46	3.61	0.136	0.143
J	4.91	5.06	0.195	0.199

NOTES

1. Suggested solder print uses some dimensions as PCB pad layout.

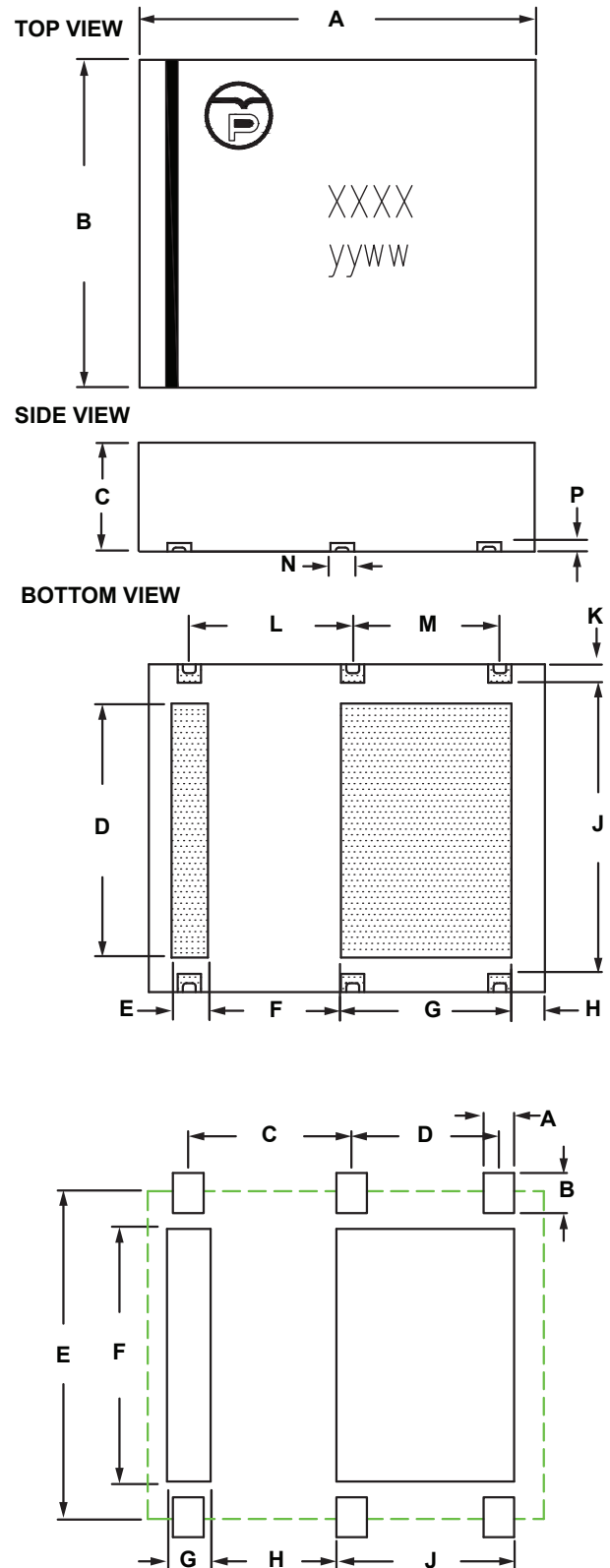

TAPE AND REEL

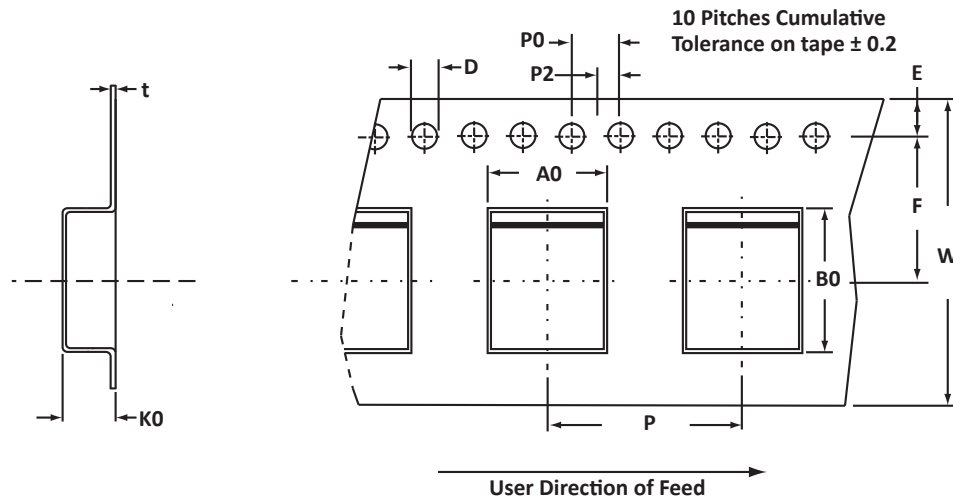

SPECIFICATIONS

REEL DIA.	TAPE WIDTH	A0	B0	K0	D	E	F	W	P0	P2	P	tmax
330mm (13")	24mm	9.40 ± 0.10	11.60 ± 0.10	3.175 ± 0.10	1.50 ± 0.10	1.75 ± 0.10	11.5 ± 0.10	24.00 ± 0.30	4.00 ± 0.10	2.00 ± 0.10	16.00 ± 0.10	0.30

NOTES

- Dimensions are in millimeters.
- Surface mount product is taped and reeled in accordance with EIA-481.
- Marking on Part - marking code (see page 2), date code, logo and polarity band (Unidirectional only).

ORDERING INFORMATION

BASE PART NUMBER (xx = Voltage)	LEADFREE SUFFIX	TAPE SUFFIX	QTY/REEL	REEL SIZE	TUBE QTY
SM30KWExxA/CA	n/a	-T13	1000	13"	n/a
SM30KWExxA/CA	n/a	-T71	100	7"	n/a
SM30KWExxA/CA	n/a	-T72	200	7"	n/a

This device is only available in a Lead-Free configuration.

COMPANY INFORMATION**RTCA DO-160G COMPLIANT PRODUCT****COMPANY PROFILE**

In business more than 30 years, ProTek Devices™ is a privately held semiconductor company. The company offers a product line of overvoltage protection that include Transient Voltage Suppressor (TVS) Arrays, Steering Diode Array Hybrids, High-power Components and Modules, as well as Steering Diodes, EMI Filter/TVS Arrays and Thyristor Surge Suppressors. These components deliver circuit protection in electronic systems from numerous overvoltage events. They include lightning; electrostatic discharge (ESD); nuclear electromagnetic pulses (NEMP); inductive switching; and electromagnetic interference (EMI) / radio frequency interference (RFI). ProTek Devices is an ISO 9001 certified company.

CONTACT US**Corporate Headquarters**

2929 South Fair Lane
Tempe, Arizona 85282
USA

By Telephone

General: 602-431-8101
Sales: & Marketing: 602-414-5109
Customer Service: 602-414-5114
Product Technical Support: 602-414-5107

By Fax

General: 602-431-2288

By E-mail:

Asia Sales: asiasales@protekdevices.com
Europe Sales: europesales@protekdevices.com
U.S. Sales: ussales@protekdevices.com
Distributor Sales: distysales@protekdevices.com
Customer Service: service@protekdevices.com
Technical Support: support@protekdevices.com

Web

www.protekdevices.com

COPYRIGHT © ProTek Devices 2018 - This literature is subject to all applicable copyright laws and is not for resale in any manner.

SPECIFICATIONS: ProTek reserves the right to change the electrical and or mechanical characteristics described herein without notice.

DESIGN CHANGES: ProTek reserves the right to discontinue product lines without notice and that the final judgement concerning selection and specifications is the buyer's and that in furnishing engineering and technical assistance. ProTek assumes no responsibility with respect to the selection or specifications of such products. ProTek makes no warranty, representation or guarantee regarding the suitability of its products for any particular purpose, nor does ProTek assume any liability arising out of the application or use of any product or circuit and specifically disclaims any and all liability without limitation special, consequential or incidental damages.

LIFE SUPPORT POLICY: ProTek Devices products are not authorized for use in life support systems without written consent from the factory.